

SILICON BRIDGE RECTIFIERS

REVERSE VOLTAGE - 50 to 1000Volts
FORWARD CURRENT - 8.0 Amperes

FEATURES

- Surge overload rating -200 amperes peak
- Ideal for printed circuit board
- Reliable low cost construction utilizing molded plastic technique
- Plastic material has UL
- Mounting position: Any
- Mounting torque: 5 In.lb. Max

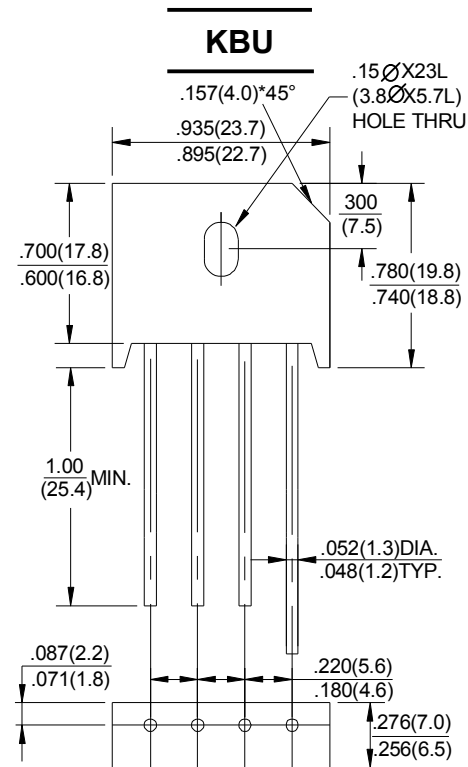

Dimensions in inches and (millimeters)

MAXIMUM RATINGS AND ELECTRICAL CHARACTERISTICS

Rating at 25°C ambient temperature unless otherwise specified.

Single phase, half wave, 60Hz, resistive or inductive load.

For capacitive load, derate current by 20%

CHARACTERISTICS	SYMBOL	KBU8005	KBU801	KBU802	KBU804	KBU806	KBU808	KBU810	UNIT
Maximum Recurrent Peak Reverse Voltage	V _{RRM}	50	100	200	400	600	800	1000	V
Maximum RMS Voltage	V _{RMS}	35	70	140	280	420	560	700	V
Maximum DC Blocking Voltage	V _{DC}	50	100	200	400	600	800	1000	V
Maximum Average Forward Rectified Output Current at T _C =100°C	I _(AV)	8.0							A
Peak Forward Surge Current 8.3ms single Half Sine-Wave Super Imposed on Rated Load (JEDEC Method)	I _{FSM}	200							A
Maximum Instantaneous Forward Voltage Drop per Element at 4.0A	V _F	1.0							V
Maximum Reverse Leakage at rated DC Blocking Voltage Per Element T _J =25°C	I _R	10							μA
Typical Junction Capacitance Per Element (Note1)	C _J	250							pF
Operating Temperature Range	T _J	-55 to +125							°C
Storage Temperature Range	T _{STG}	-55 to +150							°C

Note: 1. Measured at 1.0MHz and applied reverse voltage of 4.0V DC.

FIG.1-DERATING CURVE FOR OUTPUT RECTIFIED CURRENT

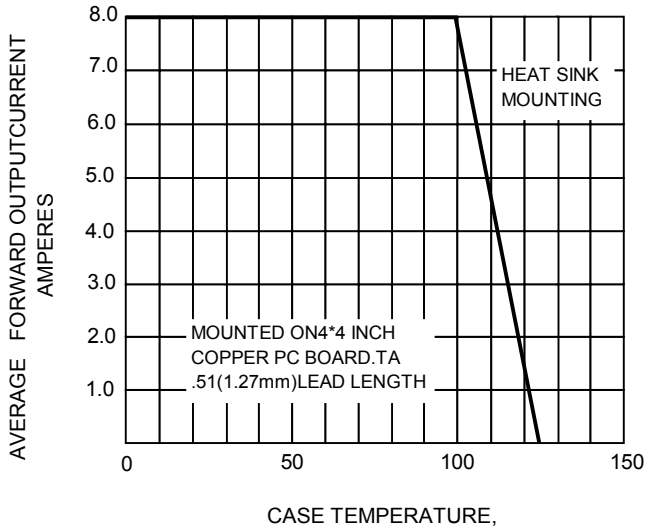

FIG.2 TYPICAL INSTANTANEOUS FORWARD CHARACTERISTIC

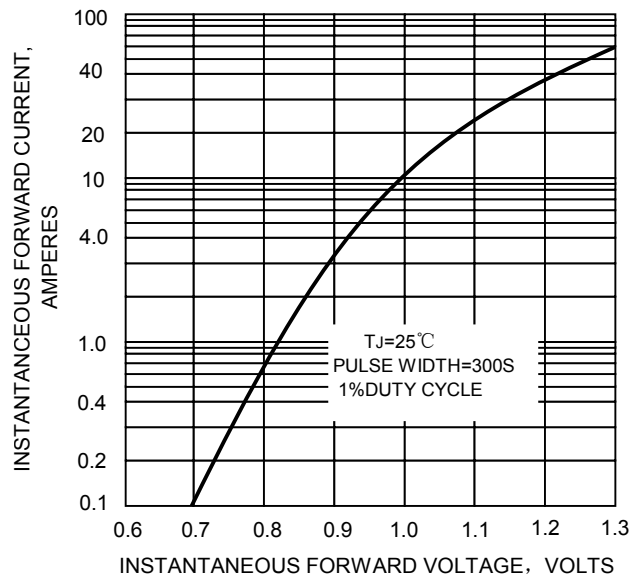

FIG.3-MAXIMUM NON-RETTETIVE PEAK FORWARD SURGE CURRENT

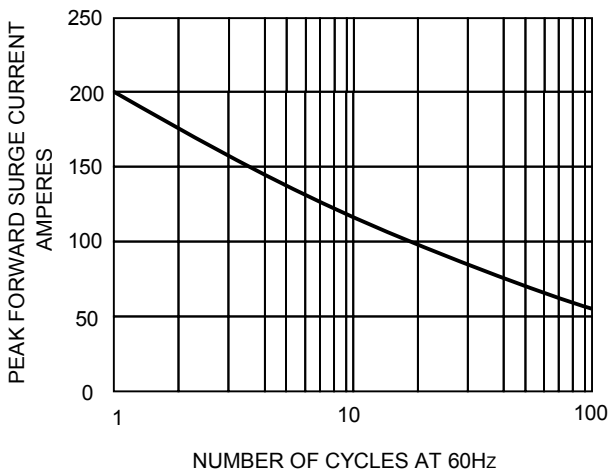

FIG.4-TYPICAL REVERSE CHARACTERISTICS

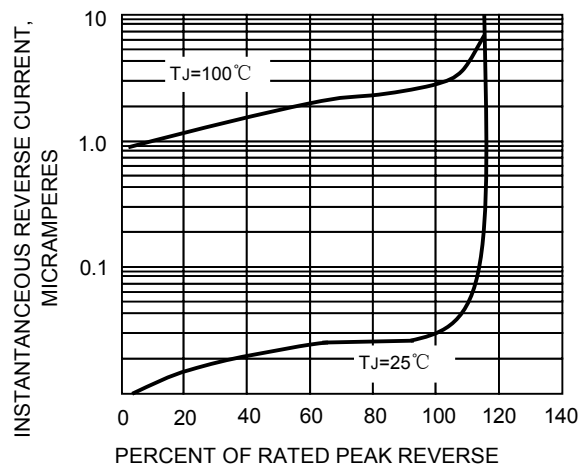

FIG.5-TYPICAL JUNCTION CAPACITANCE PER ELEMENT

